

CPU 接口

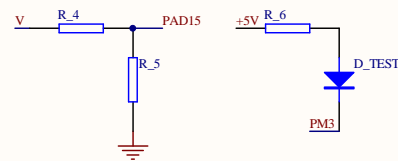

电压测量及指示电路

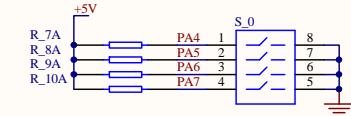
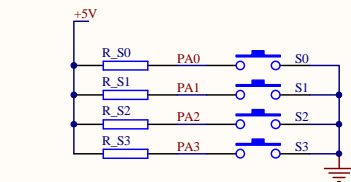
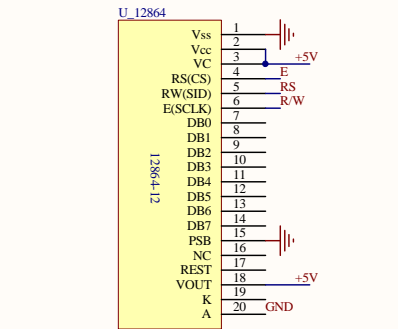
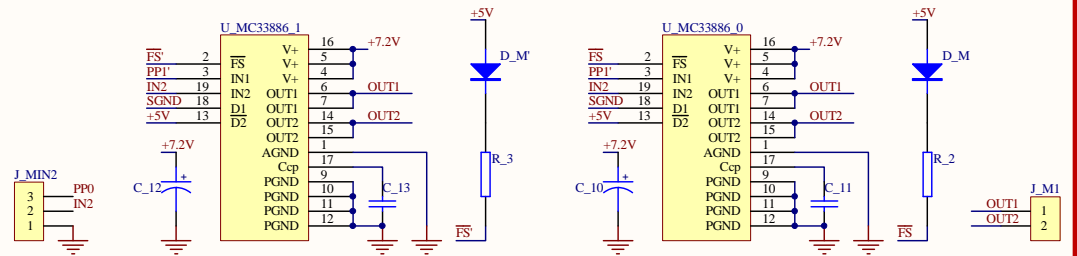

电机驱动模块

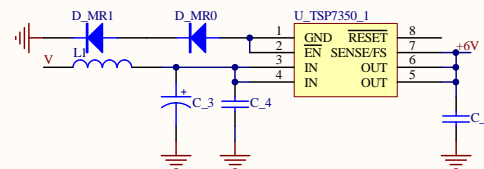

舵机稳压 +6V

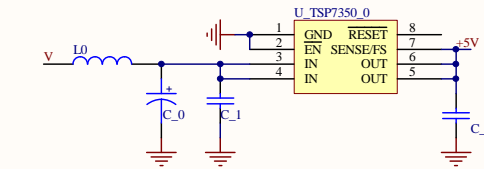

CPU稳压 +5V

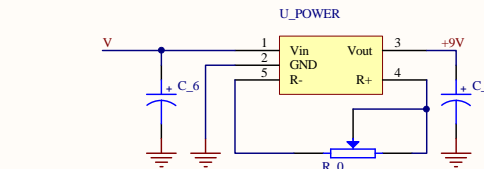

摄像头升压 +9V

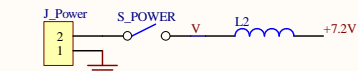

电源接口

电源模块

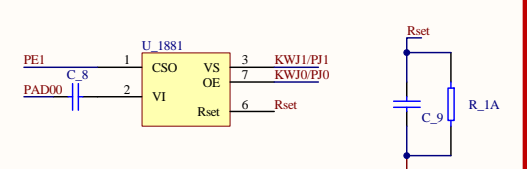

视频信号分离电路

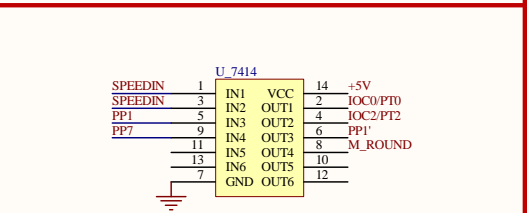

7414反相器驱动

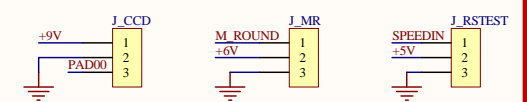

摄像头-舵机-测速接口

Title		
Size	Number	Revision
B		
Date:	2008-5-20	Sheetof
File:	J:\智能车\BackupofSheet 1.Sch	DrawnBy: